



Made for ideas.

RUGGED RAID USER MANUAL



Click [here](#) to access an **up-to-date online version**

of this document. You will also find the most recent content as well as expandable illustrations, easier navigation, and search capability.



INTRODUCTION

Welcome to the User Manual for the LaCie Rugged RAID. Your Rugged RAID features two interfaces: Thunderbolt technology and SuperSpeed USB 3.0. Both connections allow you to copy huge amounts of data at fast transfer rates. Since it is bus powered, the Thunderbolt technology cable gives you mobility while the USB 3.0 is backward compatible for universal connectivity with USB 2.0 devices.



With options for RAID 0 or RAID 1, the Rugged RAID is ideal for videographers, photographers, and heavy data users that demand extraordinary performance and protection both in the office and the field.

This manual guides you through the process of connecting your LaCie product. If you have questions, consult the [Getting Help](#) page.

BOX CONTENT

- LaCie Rugged RAID with integrated Thunderbolt cable
- USB 3.0 cable (USB 2.0 compatible)
- Removable cover and spare
- Power supply (see note below)
- Quick Install Guide
- Complete software suite

Important info: Save your packaging. In the event that the drive should need to be repaired or serviced, it must be returned in its original packaging.

MINIMUM SYSTEM REQUIREMENTS

Your system must meet certain requirements in order for your LaCie product to function properly. For a list of these requirements, please refer to the product packaging or consult the product support web page at www.lacie.com/support/.

Notes on USB 3.0:

Your PC or Mac must have a USB 3.0 port to take advantage of USB 3.0 transfer rates.

The power cable must be connected to an active outlet when using the USB 3.0 port.

Software suite

The software suite for your LaCie Rugged RAID is pre-loaded on the hard drive. The free suite of utilities includes:

- LaCie Setup Assistant (easily format and create partitions for use on Mac®, PC, or both)
- LaCie Private-Public (password protection with AES 256-bit software encryption)
- LaCie Backup Assistant (PC/Mac)
- LaCie Desktop Manager (monitor hard drive health and configure email alerts)

Software can also be found at [LaCie support](#).

INGRESS PROTECTION RATING

The Ingress Protection (IP) rating is a standard for defining the types of protection supported by equipment and devices. Users should review the IP two-digit code to understand the conditions that the device can withstand. The two digits are independent, with each number representing a different level of protection.

Your LaCie Rugged RAID is rated IP 54.

- 5: Protection against dust from entering the device's internal mechanism.
- 4: Protection against splashing water from any angle.

The LaCie Rugged RAID is also protected when it is dropped from heights up to 1.5 meters / 5 feet (in non-operating mode).

Important info on IP 54 and the removable cover: The LaCie Rugged RAID's IP 54 rating is valid when the cover is securely fastened on the device. You can attach the cover when using the integrated Thunderbolt cable. However, the cover cannot be attached when using the USB 3.0 port.

VIEWS OF THE RUGGED RAID

PORT PROTECTOR



The removable cover on the LaCie Rugged RAID offers enhanced protection for the device's ports. To remove the cover, place your index finger on its left edge and gently pry it open. The Thunderbolt cable remains attached to the cable fastener on the cap.

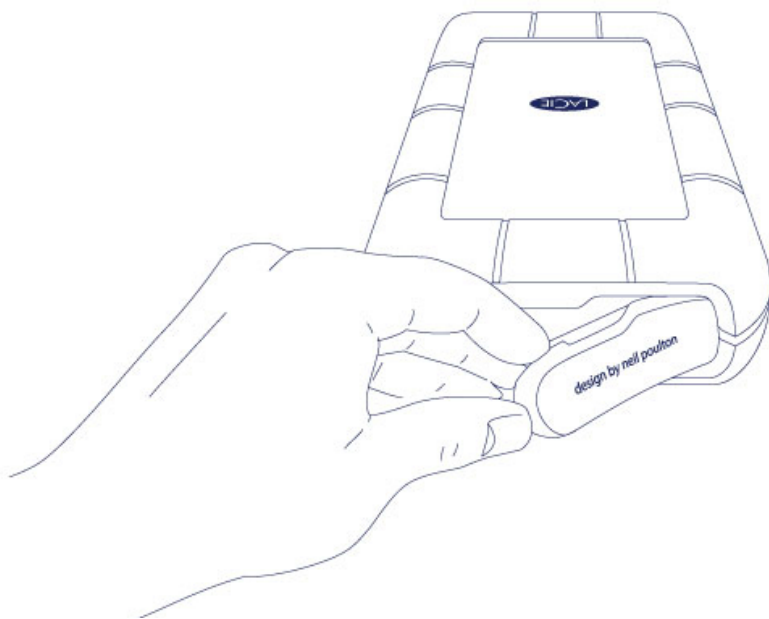

Port protection

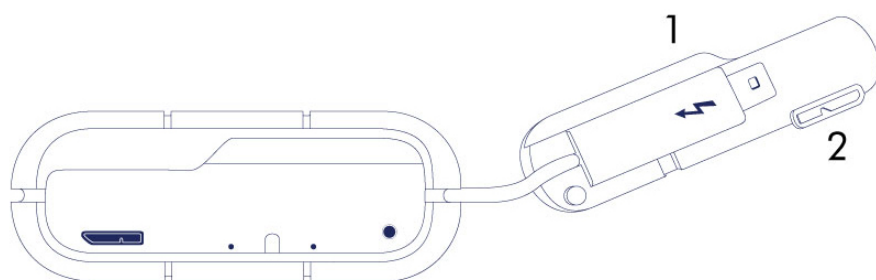

1. Fastens to the Thunderbolt cable during transport.
2. Protects the Thunderbolt cable end and the USB 3.0 port.

It is highly recommended to attach the cover when:

- Transporting the LaCie Rugged RAID.
- The integrated Thunderbolt cable is in use.

The removable cover cannot be fastened to the LaCie Rugged RAID when using the USB 3.0 port.

INTERFACES

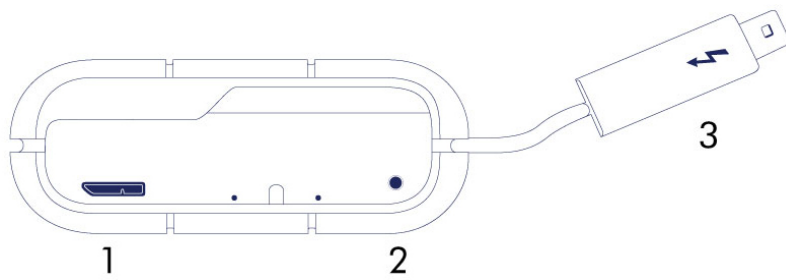

1. USB 3.0
2. Power
3. Thunderbolt cable

Important info regarding USB 3.0: The power cable must be connected to an active outlet when using the USB 3.0 port.

LEDS

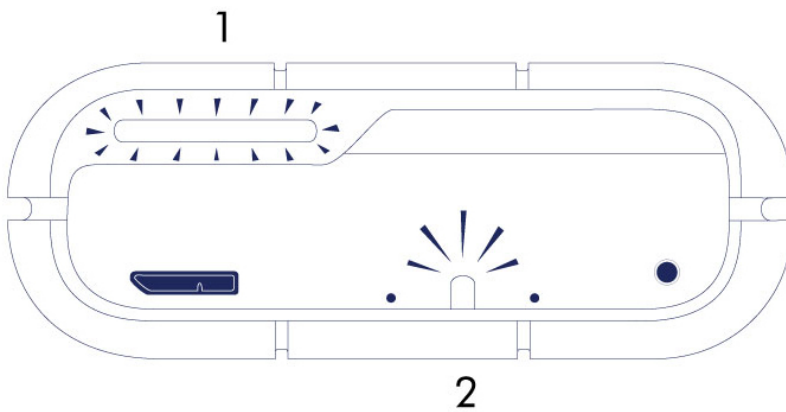

1. Activity
2. RAID

RAID BUTTONS

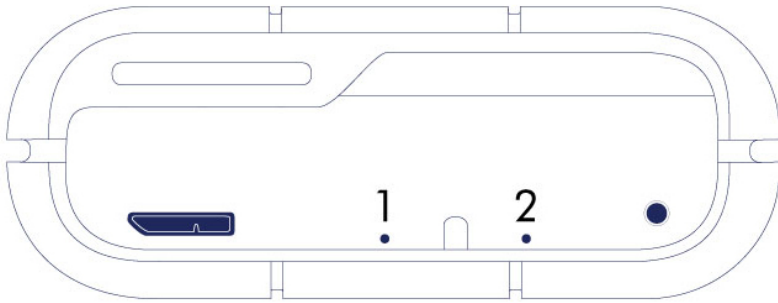

1. RAID select
2. RAID confirm

To maintain your Rugged RAID's IP54 rating, the RAID select and confirm buttons are located within small recesses. When checking or changing the RAID level, use the pointed end of a paperclip to push a button. For details, see [Manage RAID](#).

LED AND POWER

LED STATES

Activity LED

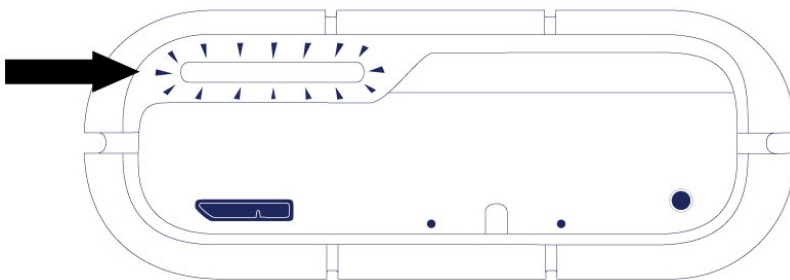

The Activity LED provides indications on the state of the Rugged RAID's health:

Behavior	State
Solid white	The device is ready.
Blinking white	The device is being accessed.
Blinking red	One or two drives are not ready or have failed.
Off	The product is: turned off; in power saving mode; not receiving power; experiencing system failure; or, experiencing electronic board failure.

Contact [LaCie technical support](#) if:

- The LED remains off but the device is connected to a power supply and to your computer. Confirm that the Rugged RAID is not in sleep mode before contacting LaCie technical support.
- The LED continues to blink red. One or both of your hard drives may have failed. **Do not swap one or both hard drives onsite or in the field.** Doing so will void the LaCie Rugged RAID's warranty.

Technical info on LED color: The Activity LED can appear orange due to the sleeve's color.

RAID LED

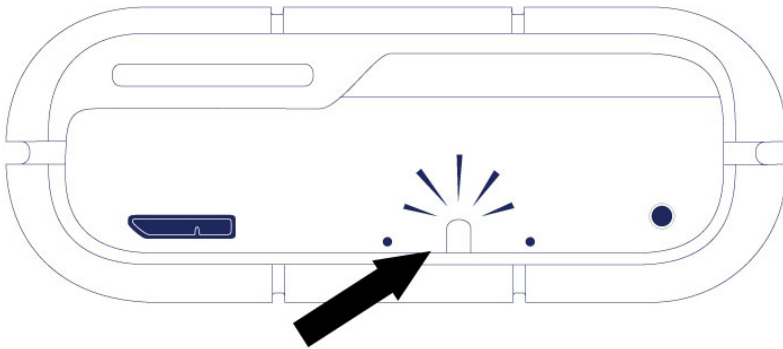

Use a thin, pointed object to push the RAID select and RAID confirm buttons. For example, use the pointed end of a paperclip to access and push the buttons.

See [Manage RAID](#) for instructions on how to check or change the RAID level.

Action	Behavior	State
Push once on the RAID select button	Solid white	The device is set to RAID 0.
Push once on the RAID select button	Blinking white	The device is set to RAID 1.
Push twice on the RAID select button	Solid white	The device will be changed to RAID 0.
Push twice on the RAID select button	Blinking white	The device will be changed to RAID 1.

RECEIVING POWER

Thunderbolt connection

The LaCie Rugged RAID powers on automatically when it is connected to a computer that supports Thunderbolt technology. Use the embedded Thunderbolt technology cable when connecting the Rugged RAID to a computer.

USB 3.0

The power cable must be connected to an active outlet when using the Rugged RAID's USB 3.0 port.

Note on the USB 3.0 connection: The Rugged RAID can be connected to a USB 2.0 port on your computer. To take advantage of SuperSpeed USB 3.0 transfer rates, you must connect the Rugged RAID to a computer with a USB 3.0 port.

POWER-SAVING MODE

Your LaCie Rugged RAID can conserve energy by entering power-saving mode. Managed by your computer, power-saving mode can extend the life of the hard drives by sparing them from working during extended periods of inactivity.

Operating system

You can initiate power-saving mode on your computer by performing one of the following:

- Place the host computer into sleep mode.
- **Mac OS:** Go to **System Preferences > Energy Saver** to enable sleep mode for hard drives.
- **Windows 8:** Go to **Control Panel > Hardware > Power Options > Choose a power plan > Change advanced power settings**. Click on **Hard disk** and **Turn off the hard disk after**. Choose the time to spin down USB hard drives.

To exit power-saving mode, review the table below:

Entering power-saving mode	Exiting power-saving mode
The host computer placed the product into power-saving mode due to inactivity.	Access the Rugged RAID's volume on the host computer. For example, copy files to its volume.
The computer is in sleep mode.	Wake up the computer.

Note on ejecting the volume and power-saving mode: The Rugged RAID enters power-saving mode when its volumes are ejected and the device remains connected to the computer. To access the Rugged RAID's volumes, unplug the interface cable from the computer and reconnect it.



CABLES AND CONNECTORS

THUNDERBOLT

Your LaCie product features Thunderbolt technology, the most flexible interface ever created. This exciting new high-speed cable technology connects your computers and electronic devices together like never before. Thunderbolt technology supports two 10Gb/s bi-directional channels from a single port, the fastest data connection available on a personal computer. At 10Gb/s, a full-length HD movie can be transferred in less than 30 seconds.

Thanks to support for both data streams and mini DisplayPort video, you can connect either a storage peripheral or a display to a Thunderbolt port. However, it's not possible to use a mini DisplayPort cable to connect a storage peripheral to a Thunderbolt port. You must use a Thunderbolt cable.

For more information, see www.lacie.com

Connector Face (to computer)	Cable End (to computer)
	

Integrated cable

For ease of access, the Thunderbolt cable is integrated on your LaCie Rugged RAID. Remove the interface cover and gently unwind the Thunderbolt cable before attaching it to your Mac or PC.

Holding, dangling, or transporting the Rugged RAID by its integrated cable is strongly discouraged. Doing so can invalidate the product warranty.

Thunderbolt technology and Windows





Windows users must connect the product via USB to configure the Rugged RAID for PC. See [Getting Connected](#) for details.

USB 3.0

USB is a serial input/output technology for connecting peripheral devices to a computer. SuperSpeed USB 3.0 is the latest implementation of this standard, and it provides higher bandwidth and new power management features.

Transfer rates can attain up to 5 Gbits/s as opposed to USB 2.0's 480 Mbits/s. This means USB 3.0 is theoretically up to ten times faster than its predecessor.

Your LaCie drive is shipped with a SuperSpeed USB 3.0 cable to ensure maximum data transfer performance when connected to a compatible USB 3.0 port. The cable will also work when connected to a USB 2.0 or 1.1 port, but drive performance will be limited to their respective transfer rates.

Connector Face (to Computer)	Cable End (to Computer)	Cable End (to Hard Drive)	Connector Face (to Hard Drive)
			

Note on USB 3.0:

Your PC or Mac must have a USB 3.0 port to take advantage of USB 3.0 transfer rates.

The included power cable must be connected to an active outlet when using the Rugged RAID's USB 3.0 port.

GETTING CONNECTED

Setting up the LaCie Rugged RAID is easy thanks to LaCie Setup Assistant. Follow the steps in the order they are given to ensure that your LaCie Rugged RAID's volume mounts correctly on your computer.

THUNDERBOLT AND WINDOWS

Important info: Thunderbolt technology is compatible with Windows 7 and Windows 8.

Windows requires a driver to use the Thunderbolt port. For the initial setup, connect the product to a host computer via USB and run LaCie Setup Assistant (see [Step 2 - Launch LaCie Setup Assistant](#)). You can connect via the Thunderbolt interface once LaCie Setup Assistant has successfully formatted your device and the Thunderbolt driver is installed.

STEP 1 - CONNECT THE INTERFACE CABLE

First connection

Mac: The LaCie Rugged RAID can be connected to your Mac using the integrated Thunderbolt cable or the included USB 3.0 cable. However, it is not possible to use both interfaces at the same time.

Windows: For the initial setup, you must use the USB 3.0 cable. If your PC has a Thunderbolt port, make certain to install the Thunderbolt driver when prompted by LaCie Setup Assistant. Once the driver is installed, you can connect the Rugged RAID to your PC via Thunderbolt.

Important info on USB 3.0: The power cable must be connected to an active outlet when using the Rugged RAID's USB 3.0 port.

Thunderbolt

1. Remove the cover by placing your index finger on its left edge and gently prying it open. Use caution since the Thunderbolt cable is held by a fastener on the removable cover.

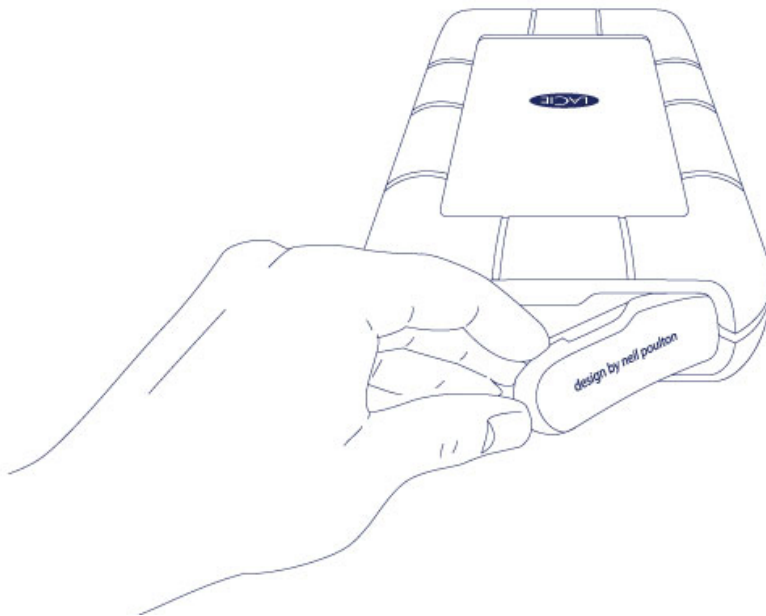

2. Gently remove the Thunderbolt connector from the cover.
3. Unwind the integrated Thunderbolt cable as needed and connect it to your computer.

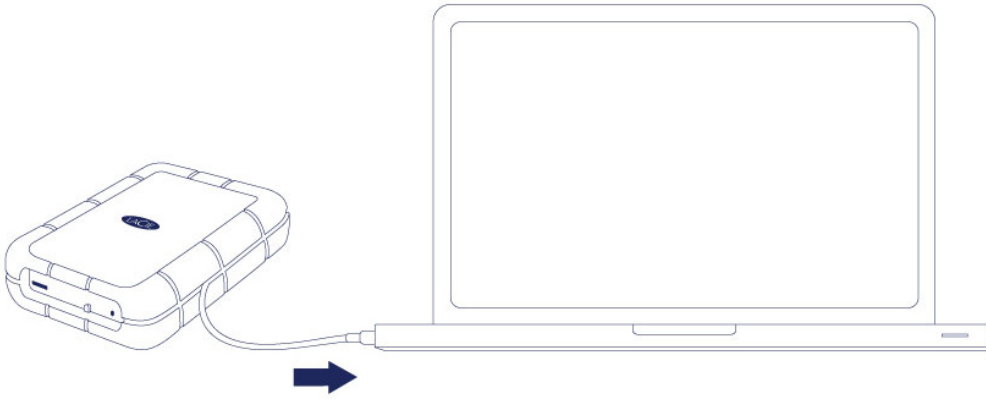

4. The drive mounts on your desktop (Mac).

5. Replace the cover on the LaCie Rugged. Doing so maintains the LaCie Rugged's IP 54 rating.

If the Rugged RAID's *Setup* volume does not mount on your computer, see troubleshooting topics at [Getting Help](#).

USB 3.0

1. Remove the cover by placing your index finger on its left edge and gently prying it open. Use caution since the Thunderbolt cable is held by a fastener on the removable cover.

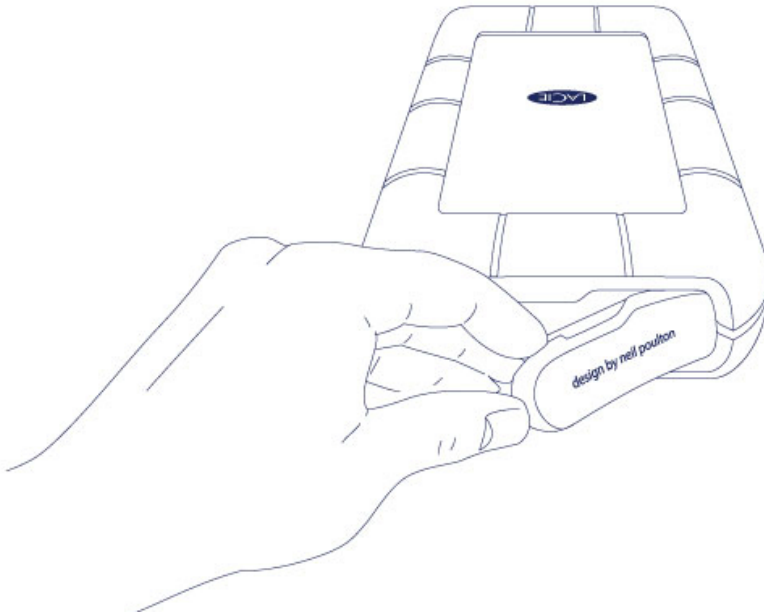

2. Connect the included power cable in the following order:

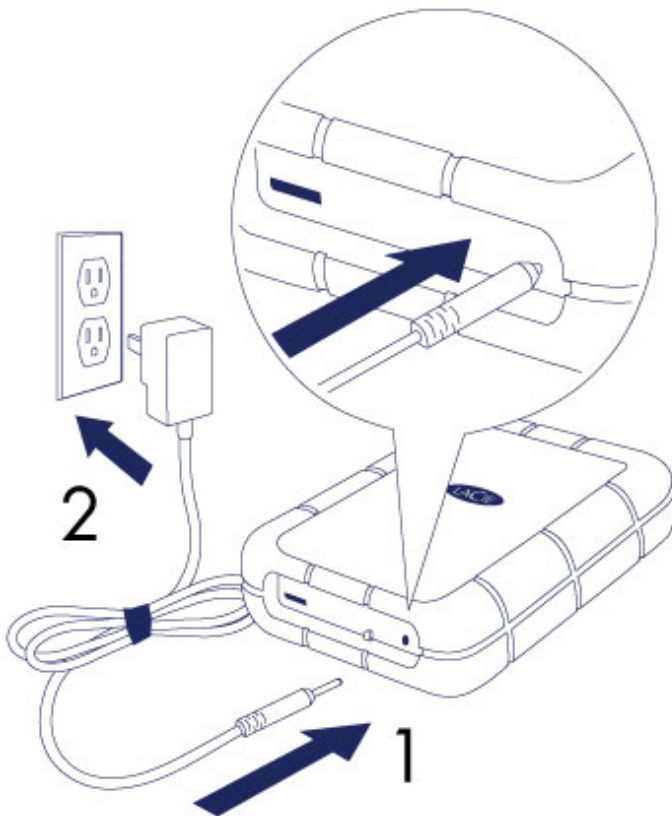

1. The Rugged RAID.
2. An active outlet.
3. Use the included USB 3.0 cable to connect the Rugged RAID in the following order:

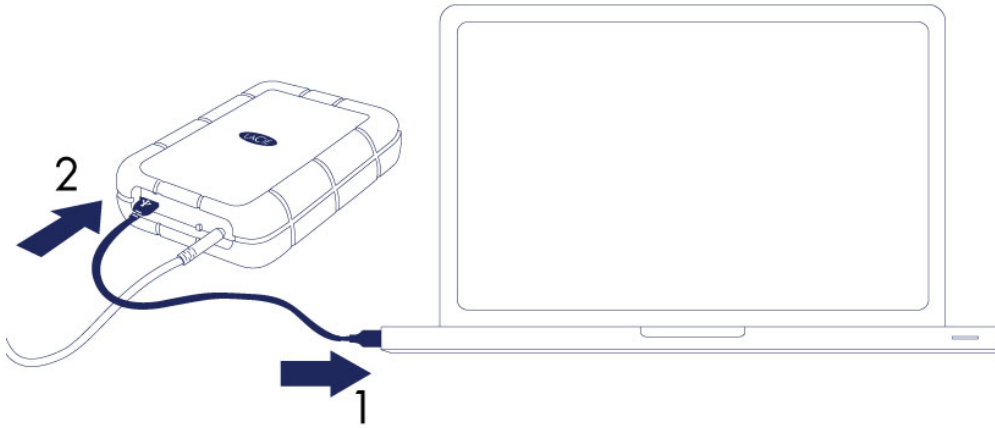

1. A USB 3.0 or USB 2.0 port on your computer.
 2. The USB port on the Rugged RAID.
 4. The drive mounts in **Computer** (Windows Vista, Windows 7, and Windows 8) or, on your desktop (Mac).
- If the Rugged RAID's *Setup* volume does not mount on your computer, see troubleshooting topics at [Getting Help](#).

USB 3.0 connections:

The power cable must be connected to an active outlet when using the Rugged RAID's USB 3.0 port.

Since the cover cannot be replaced when using the USB 3.0 connection, the Rugged RAID's IP 54 rating is not in effect.

STEP 2 - LAUNCH LACIE SETUP ASSISTANT

Important info for Windows users: LaCie Setup Assistant only works through the USB connection. Therefore, connect the device via USB and run LaCie Setup Assistant. If your PC features a Thunderbolt port, you can connect to it once LaCie Setup Assistant has successfully formatted your device and the Thunderbolt driver is installed.

Launch LaCie Setup Assistant before using your device. It allows you to:

- Easily format the device according to your needs.
- Copy the user manual to your computer.
- Install software for added features.
- Register your LaCie device.

Important info: If you do not launch LaCie Setup Assistant or, if you quit it after the formatting has begun, your drive will not be ready to use and will require manual formatting. In such a case, the user manual and utilities must be downloaded from the LaCie website: www.lacie.com/support/.

Launch LaCie Setup Assistant

Windows users

AutoPlay: Windows AutoPlay may detect your LaCie device as soon as it is connected to your computer. If the AutoPlay window appears, choose **Open folder to view files using Windows Explorer** and double-click **LaCie Setup**.

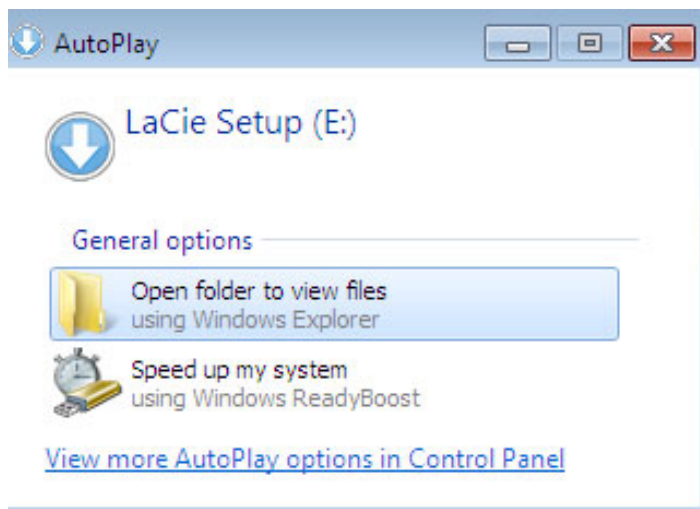

Manual access: Open the **LACIE SETUP** volume in **Computer** and double-click **LaCie Setup**.

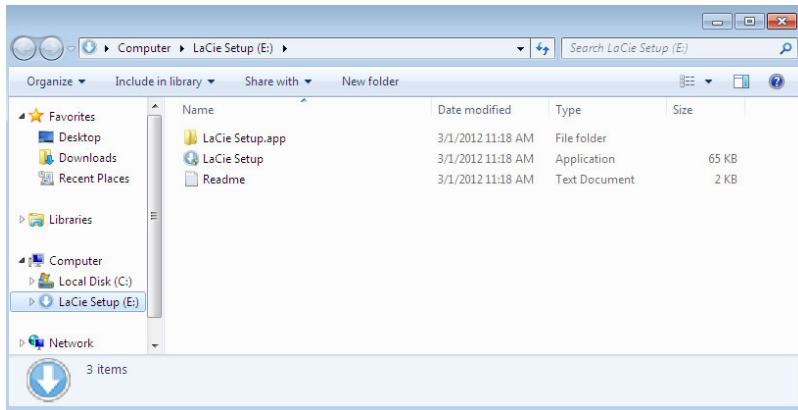

Mac users

Open the **LACIE SETUP** volume on your desktop and then double-click **LaCie Setup**

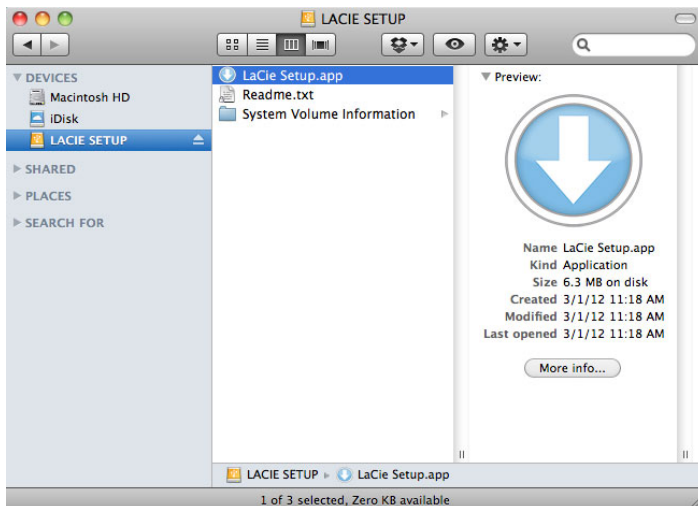

Setup

LaCie Setup Assistant does not prevent you from using your computer's native disk utility program to format or partition your LaCie drive. You can follow LaCie Setup Assistant through completion and then use Disk Management for Windows or Disk Utility for Mac to reformat your drive. If you format the device using your operating systems hard drive utility, the user manual and utilities must be downloaded from the LaCie website: www.lacie.com/support/.

Important info for Windows users: While running LaCie Setup Assistant, you may see a User Account Control dialogue asking if you wish to change your computer's settings. This is a normal request when formatting a disk or installing certain software, such as Genie Timeline. To successfully complete LaCie Setup Assistant, LaCie recommends that you agree to change the settings.

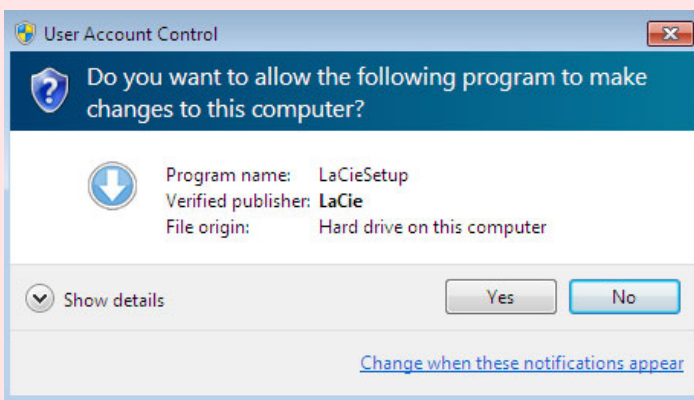

Important info for Mac users: You may be prompted to enter your computer's administrator password to continue with LaCie Setup Assistant.

Follow the on-screen instructions as listed below to format your device and install software utilities:

1. Select your language.

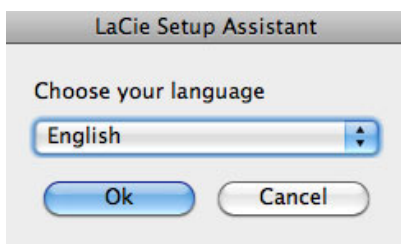

2. Read the license agreement before choosing **Next**. Selecting **Next** confirms that you accept the license agreement.

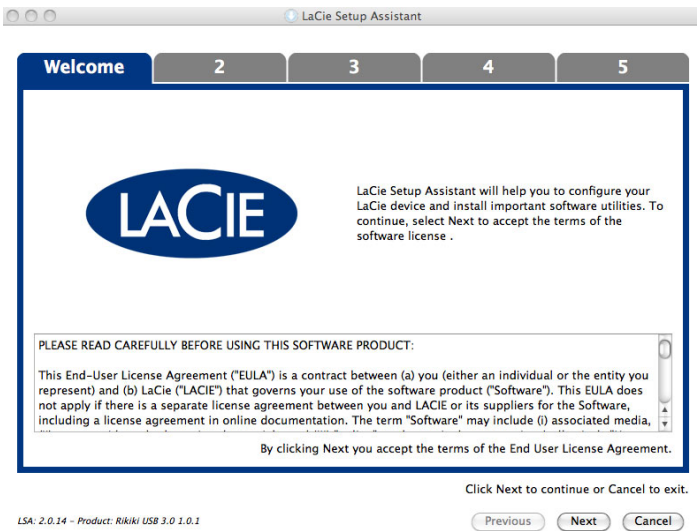

3. Use the slider to partition your LaCie device. You can:
 - Move the slider all the way to left. Doing so creates a single partition for use with your operating system. The partition format is NTFS for Windows or HFS+ for Mac.
 - Keep the slider at its current position or adjust it to the left. Doing so creates two partitions, one for use with your operating system only and the other for use with Windows and Mac. The first partition's format is NTFS for Windows or HFS+ for Mac. The second partition's format is FAT32. **Note on FAT32:** While FAT32 partitions can be used on Windows and Mac, it has a file size limitations of 4GB. Further, FAT32 is not optimized for performance with Windows and Mac.
4. Choose **Next** to format the device.

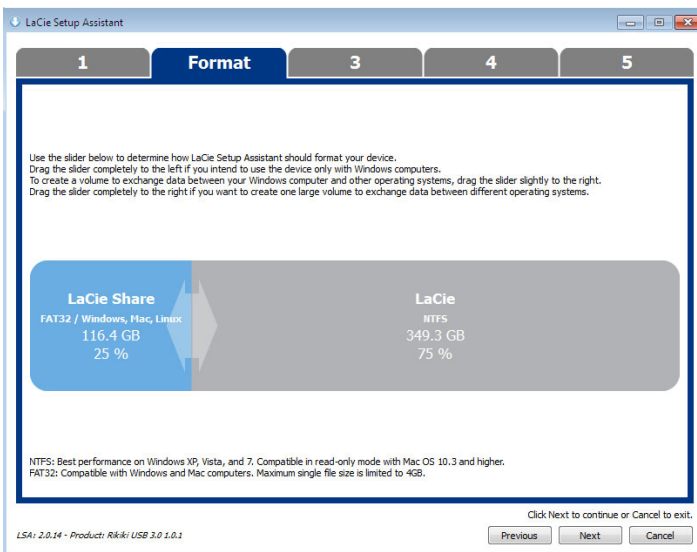

Windows

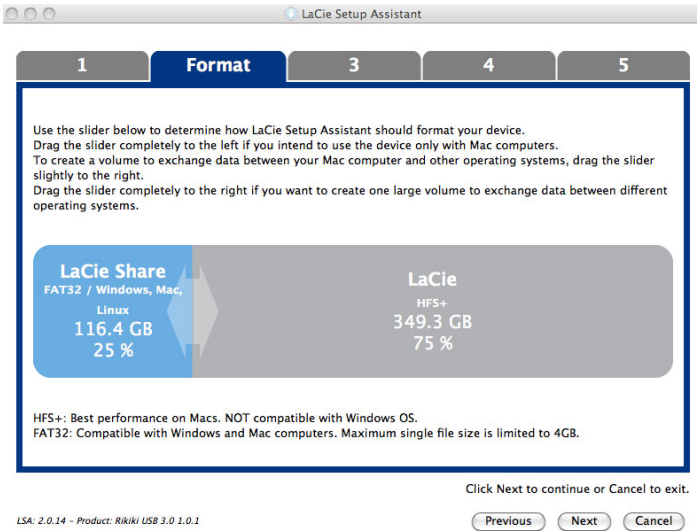

Mac

5. A prompt alerts you that the disk will be formatted. Select **Yes** to continue.

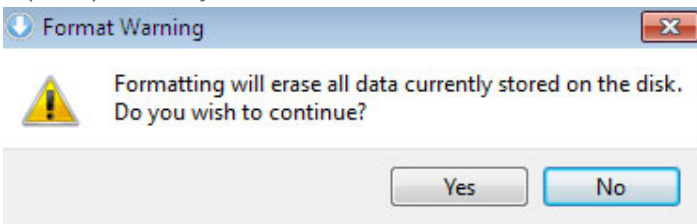

Windows

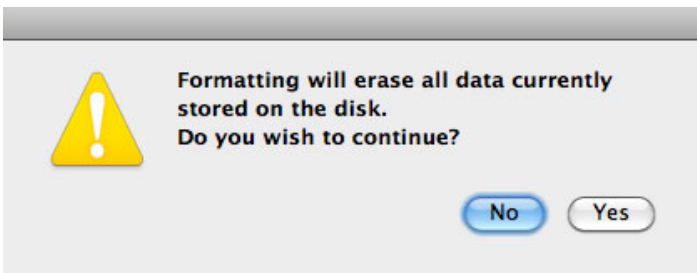

Mac

6. Register your LaCie device. Choose **Next** to continue.

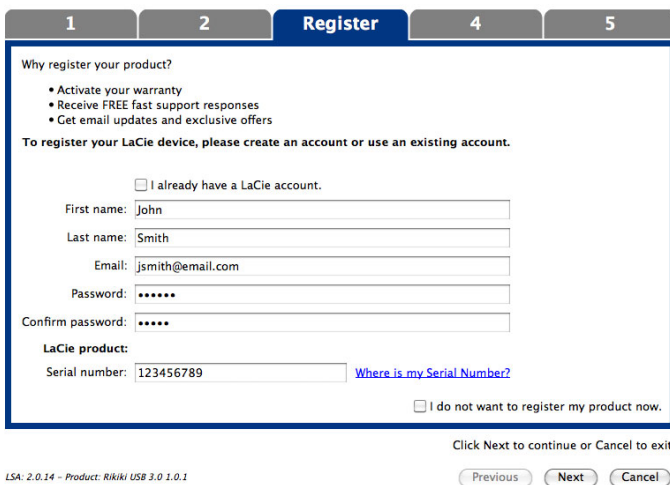

New Account

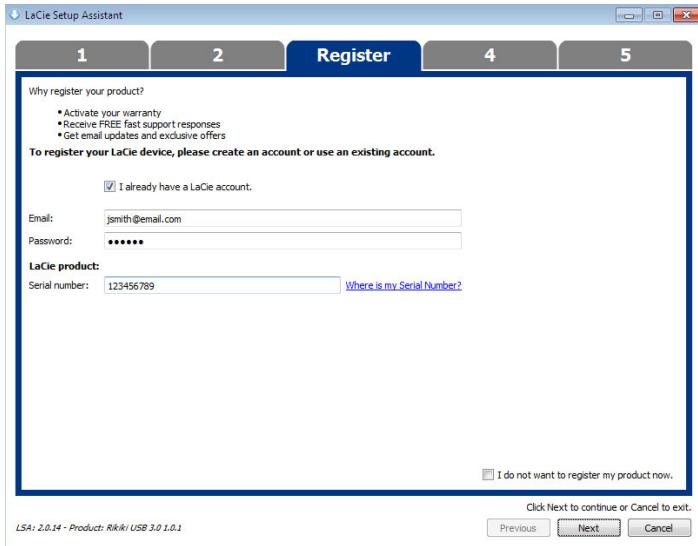

Existing Account

7. Choose the software utilities that you want to install. Certain software utilities may begin to install before LaCie Setup Assistant has finished. Follow the software utility installer before completing LaCie Setup Assistant. **Windows and Thunderbolt:** If your PC features a Thunderbolt port, choose the Thunderbolt driver as one of the software utilities to install.
8. Choose **Next** to continue.
9. LaCie Setup Assistant provides a summary of the installation. Choose **Finish** to close the program.

LaCie software utilities can be installed at any time. Once the format is complete, the LaCie Setup Assistant application is available on one of the following partitions:

- *LaCie*: If you created one partition.
- *Compatible*: If you created two partitions.

To install the software utilities, launch LaCie Setup Assistant and follow the steps listed above.

Note on RAID level: The default RAID level is 0. See [Manage RAID](#) for instructions on how to check and change the RAID level.

UNMOUNTING THE VOLUMES

In order to avoid file system corruption, it is important to unmount your LaCie device's volume before turning it off or disconnecting the interface cable. See [Unmounting Your Hard Drive](#) for details.

MANAGE RAID

ABOUT RAID MODES

Review the table below for an overview of the different RAID modes:

RAID mode	Capacity	Protection	Speed	Factory default
RAID 0	100%	None	Excellent	Yes
RAID 1	50%	Excellent	Good	No

RAID 0: RAID 0 is the fastest RAID mode. In a RAID 0 array, the available capacities of each hard drive are added together so that one logical volume mounts on the computer. It offers the best performance but no data protection should a hard drive fail.

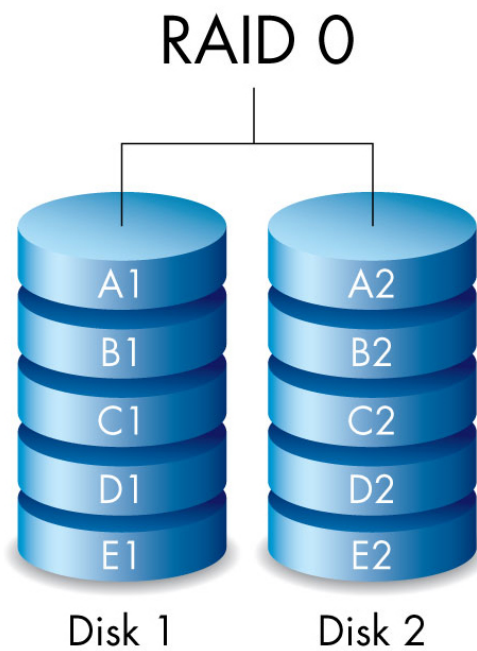

RAID 1: RAID 1 provides data protection since all data is written to each hard drive at the same time. In the event of a single hard drive failure, data remains available on the other hard drive. Due to the time it takes to write the data twice, performance is reduced when compared to RAID 0. RAID 1 is a good choice when safety is more important than speed. However, RAID 1 also reduces the available drive space by 50% due to the need to write every bit of data to each hard drive.

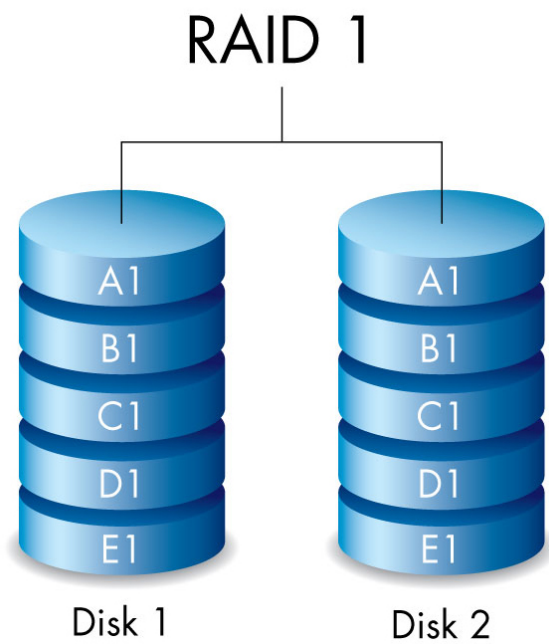

CHECK THE RAID LEVEL

You can check the current RAID level in LaCie Desktop Manager (see [LaCie Desktop Manager](#)) or by using the RAID select button.

To check the RAID level using the RAID select button:

- Confirm that the Rugged RAID is connected to a computer and powered on.
- Locate a thin, pointed object such as the end of a paperclip.

Follow the steps below:

1. Use the pointed end of the paperclip to push the RAID select button. The RAID select button is located within a small recess.

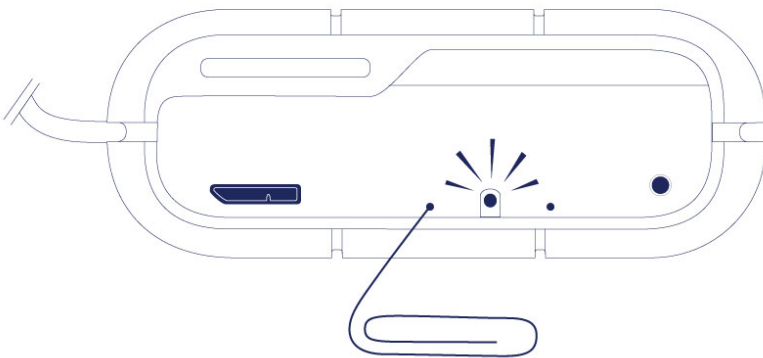

2. The RAID LED:

- Turns solid if the device is set to RAID 0.
- Blinks if the device is set to RAID 1.

The RAID LED provides the current level for approximately 5 seconds.

MODIFY THE RAID LEVEL

Important info: Changing the RAID level deletes data stored on the LaCie Rugged RAID. Back up all your data before adjusting the RAID.

Consider the following before moving to the steps below:

- Confirm that the Rugged RAID is connected to a computer and powered on.
 - The RAID select and RAID confirm buttons are located within small recesses. To push them, you can use a thin pointed object such as the end of a paperclip.
 - Know the the RAID level you want to use.
 - Step 4 is time sensitive.
1. Unmount the LaCie Rugged RAID's volumes from your computer (see [Unmounting Your Hard Drive](#)).
 2. Use the pointed end of the paperclip to push the RAID select button two times. Make certain that the second push is applied immediately after the first push.

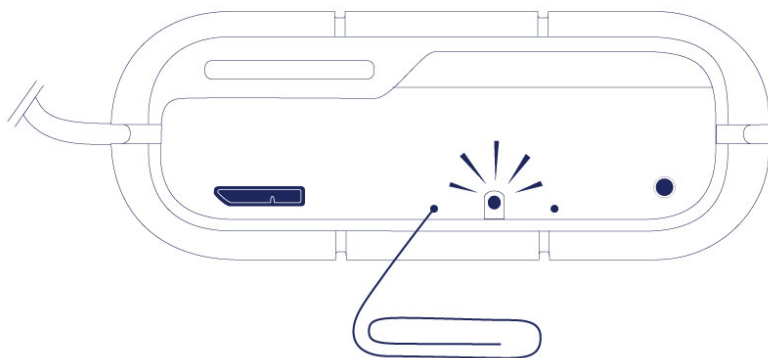

3. The RAID LED:
 - Turns solid if the device will be changed to RAID 0.
 - Blinks if the device will be changed to RAID 1.
4. Use the pointed end of the paperclip to push the RAID confirm button. The RAID confirm button must be pushed within five seconds of completing the second push of the RAID select button. The Rugged RAID restarts after pushing the RAID confirm button.

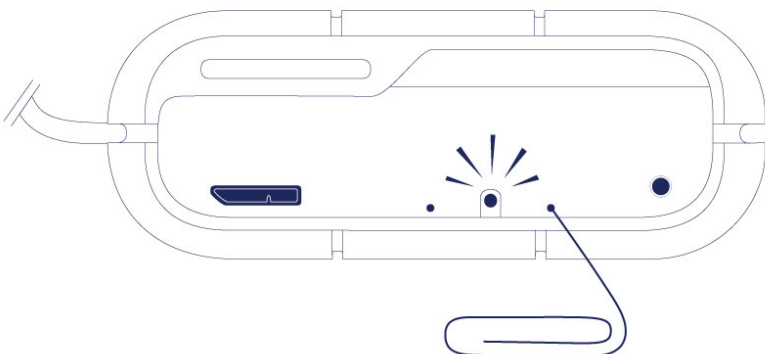

5. Once the Rugged RAID has restarted, your computer prompts you to initialize the new volume. You must

initialize and format the hard drives for use with your computer (see [Optional Formatting and Partitioning](#)).

Important info: If the RAID mode has not been changed, you can try the steps again. When following the steps, make certain to push the RAID confirm button as soon as the LED indicates your preferred RAID mode.

LACIE DESKTOP MANAGER

LaCie Desktop Manager is a software utility that provides important information regarding the status and health of your device.

INSTALLING LACIE DESKTOP MANAGER

If LaCie Desktop Manager is not installed on your computer (check your Windows system tray or Mac menu bar), you can install it:

1. Double click the Rugged RAID's volume in Computer (Windows) or on the Desktop (Mac).
2. Open the LaCie/Software folder.
3. Launch the installer located in the folder for your operating system.

When setup is complete, launch LaCie Desktop Manager from the system tray (Windows) or the menu bar (Mac).

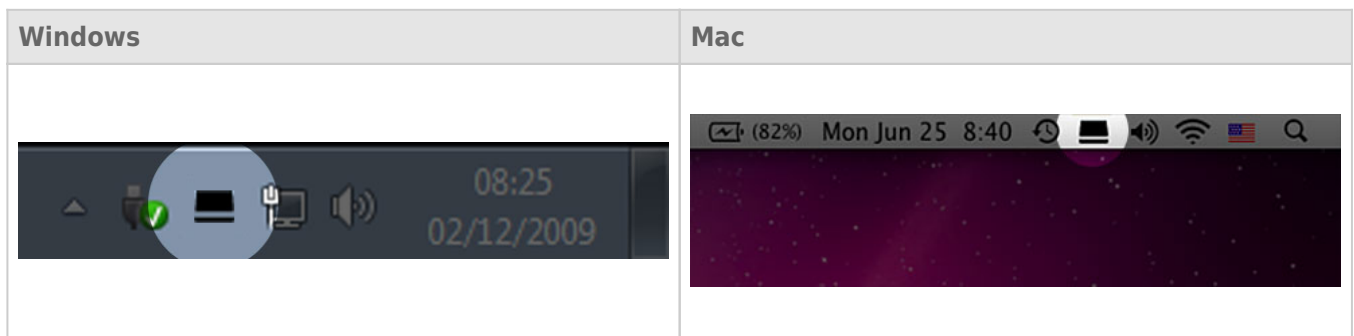

LaCie Desktop Manager provides a list of all compatible LaCie devices in the left-hand column. If you have more than one compatible LaCie device, choose a product and use the tabs to navigate to the page you want. Options can vary based upon the product.

INFO TAB



Review the details of your device:

- Name
- Model
- Hard drive ID
- Connection type
- Total capacity
- Available capacity

REFORMAT

From the **Info** tab, you can reformat the hard drives.

Caution: Choosing **Reformat** launches your operating system's disk utility (see [Optional Formatting and Partitioning](#) for details). Formatting erases all data stored on your hard drives. To protect files, back up your hard drives before selecting **Reformat**.

STATUS TAB

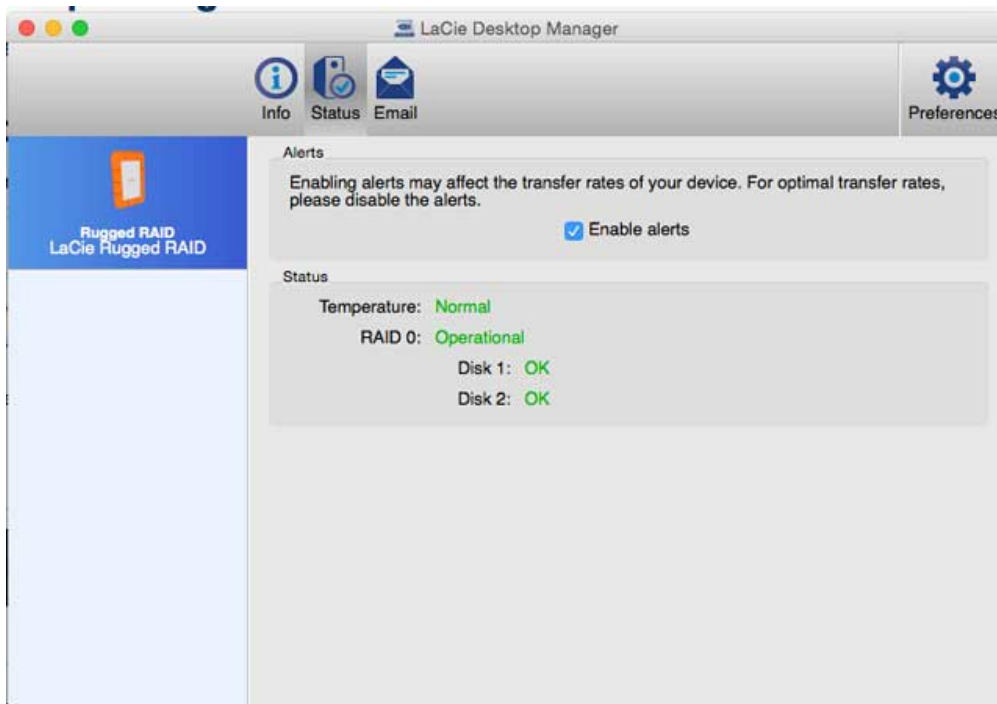

Review the health of the:

- Hardware
- RAID configuration

You can also enable alerts to receive status updates.

Important info: Activating alerts may affect the transfer rates of your device. For optimal transfer rates, disable alerts.

EMAIL TAB

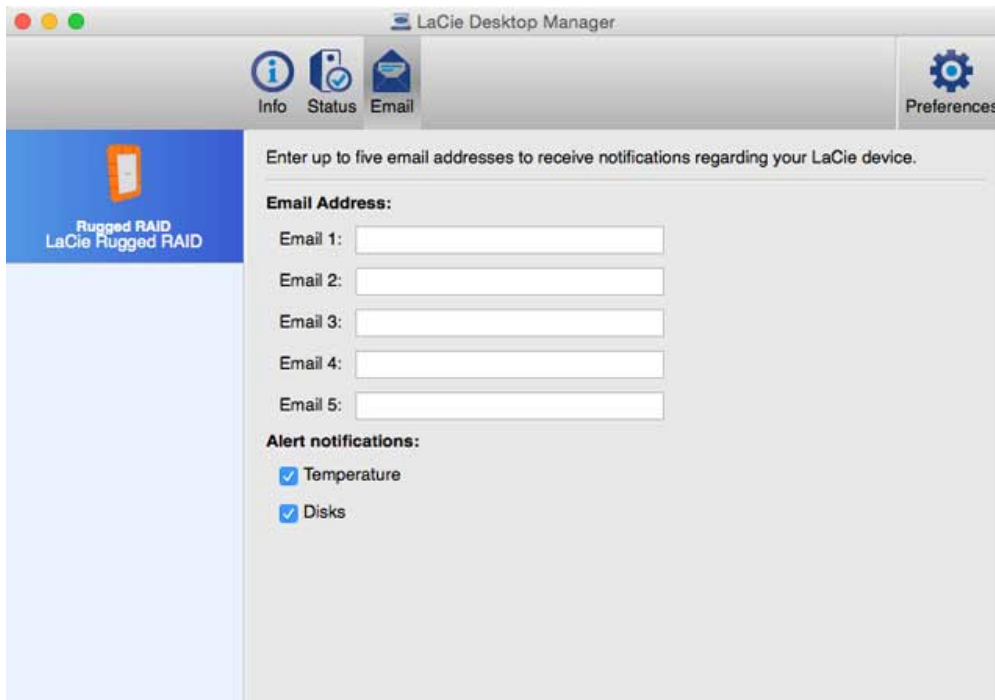

You can enter up to five email addresses to receive messages regarding changes to the status of your LaCie device. You can also enter an email subject line.

Check the boxes to select the events that trigger email alerts.

OPTIONAL FORMATTING AND PARTITIONING

Standard LaCie storage devices prompt you to run LaCie Setup Assistant when they are first connected to a PC or Mac. LaCie Setup Assistant helps you to quickly format the storage device according to your needs.

Read the information below carefully if you:

- Abort LaCie Setup Assistant while it is formatting.
- Wish to reformat your storage device after LaCie Setup Assistant has successfully completed.
- Own a LaCie storage device that does not feature LaCie Setup Assistant.

ABOUT FILE SYSTEM FORMATS

You can customize the storage device by reformatting and/or partitioning it with separate file system formats.

Mac

For optimal performance in Mac OS environments, format and partition the storage device as one large Mac OS Extended volume.

Mac OS Extended (HFS+): Mac OS Extended refers to the file system used by Mac OS X. HFS+ represents an optimization of the older HFS file system by using hard disk space more efficiently. With HFS+, you are no longer limited by block size.

FAT32: FAT32 is an older format with a maximum single file size limited to 4GB. Performance is far from optimal when using FAT32.

exFAT: exFAT is an update of FAT32. It allows for volumes up to 128PB and files up to 16EB. Similar to FAT32, exFAT is not optimized for Mac and recommended only if you intend to share files with Windows devices.

See the table below for a comparison between HFS+ and exFAT.

Mac file system formats
Use HFS+ if:
...you will be using the storage device on Macs only. Performance is far superior when compared to FAT32 and exFAT. HFS+ is NOT compatible with Windows.
Use exFAT if:
...you will be using your storage device with both Windows and Mac computers.

Windows

FAT32: FAT is an acronym for File Allocation Table. Originally, FAT was only 16 bits, but after the second release of Windows 95 it was upgraded to 32 bits, hence the name FAT32.

FAT32 is supported by Windows 7 and Windows 8 but the volume size is limited to 32GB and the individual file size is limited to 4GB.

Technical info: FAT32 can reduce the performance of your LaCie product.

exFAT: exFAT is an update of FAT32. It allows for volumes up to 128PB and files up to 16EB. Similar to FAT32, exFAT is not optimized for performance with Windows devices.

NTFS: This acronym stands for New Technology File System, and it is the native file system for Windows 7 and Windows 8. NTFS offers several features that are not available with FAT32: file compression, encryption, permissions, auditing, and mirroring drives. The minimum supported volume size for NTFS is 10MB with a maximum of 2TB when initialized in the MBR format. For greater flexibility, use the GPT format with NTFS to remove limits on file and partition sizes. Volumes created in NTFS are native read and write for Windows 7 and Windows 8. Mac OS X 10.5 or higher can read and write to the NTFS partitions with the help of third-party drivers.

See the table below for a comparison of NTFS and FAT32.

Windows file system formats
Use NTFS if:
...you will be using the storage device only with Windows 7 and Windows 8. NTFS performance is significantly better than FAT32 or exFAT. This file system is also compatible in read-only mode with Mac OS 10.5 and higher.
Use exFAT if:
...you will be using your storage device with both Windows and Mac computers.

FORMATTING INSTRUCTIONS

The steps listed below can help you to format and partition a storage device.

Caution: Formatting erases everything on the storage device. **LaCie highly recommends that you back up all data on your storage device before performing the steps below. LaCie is not responsible for any data lost due to formatting, partitioning, or using a LaCie storage device.**

Important Info: Formatting the **LaCie** partition deletes the included user manual and utilities. Copy all data, including documentation and software from the LaCie partition, before formatting your storage device. User manuals and select software can also be downloaded from [LaCie technical support](#).

Note: Refer to your operating system's documentation for more information on formatting and partitioning your storage device.

Mac

1. Make sure the storage device is connected to and mounted on the computer.
2. Select **Utilities** from the **Go** menu in the Finder menu bar.
3. In the Utilities folder, double-click **Disk Utility**.

Disk Utility displays the message **Select a disk, volume, or image**. All connected storage devices, partitions, or disk images are displayed in this column. Storage devices in this column may have multiple listings. The top name is the name of the physical device's manufacturer, and includes the formatted capacity.

4. Select the storage device in the left-hand column.
5. Click the **Erase** tab.
6. Choose a format from the drop-down window. See **About File System Formats** for more information on choosing a file format.
7. Give the volume a name.
8. Click **Erase...** and confirm your selection in the popup window.

Windows

1. Make sure the storage device is connected to the PC.
2. Right click on **Computer** and choose **Manage**. From the Manage window select **Disk Management**.
3. From the list of storage devices in the middle of the Disk Management window, locate your LaCie device.
4. By default, a partition is already created on the device with LaCie software utilities. LaCie recommends leaving this partition as it is to access software and documentation.
5. To create a new partition, right click on the volume you want to format and select **New Simple Volume**. Follow the on-screen instructions when the New Simple Volume Wizard appears.

UNMOUNTING YOUR HARD DRIVE

USB, FireWire, Thunderbolt, and eSATA external devices feature “plug & play” connectivity, which means that your LaCie storage can be connected and disconnected while the computer is running. To prevent failures, however, it is important to follow these steps when disconnecting your device.

MAC

Drag the storage device icon to the Trash. (The icon pictured below is a generic USB device icon. Your LaCie storage may be represented by an icon that looks like the device itself.)

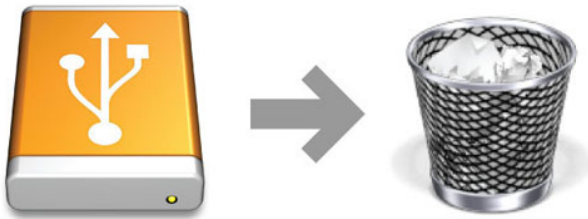

When the icon disappears from the desktop, the storage device can be disconnected.

WINDOWS 7 AND WINDOWS 8

From the System Tray (located in the lower right-hand side of your screen) click on the plug icon (note the white check mark inside a green circle).



A message will appear, detailing the devices that may be safely unmounted.

Select **Eject** for the device you wish to unmount. A message will appear notifying you that it is safe to remove it.

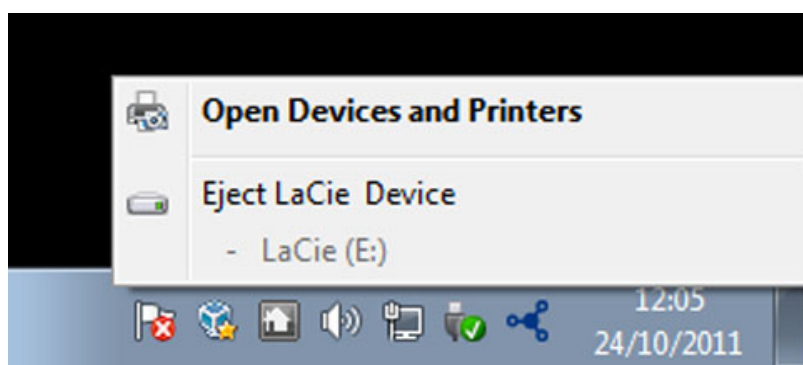

GETTING HELP

If you are having problems with your LaCie product, consult the table below for a list of available resources.

Order	Source	Description	Location
1	Quick Install Guide	Concise steps to follow for getting your product up and running	Either a printed leaflet or accessory box and included in the product box, or download PDF from the product page
2	Support Pages	Includes interactive troubleshooting topics for most common problems	www.lacie.com/support/ , select your product, then click the "Troubleshooting" tab
3	User Manual	Includes common troubleshooting topics	See Troubleshooting Topics below
4	Customer Support	Create an account on lacie.com , register your product, and fill out a support ticket	Create an account here: www.lacie.com/us/mystuff/login.htm?logout&rtm=mystuff

Note: LaCie is dedicated to providing high quality products that enrich the lives of our customers. To help LaCie offer the best customer support, we encourage you to create an account and register your product at www.lacie.com/us/mystuff/login.htm?logout&rtm=mystuff. You can give us important feedback as well as receive updated information on your LaCie device.

TROUBLESHOOTING TOPICS

Note: Interactive troubleshooting, a highly effective way to resolve problems with your product, is available from [LaCie technical support](#). Select your product, then click the “Troubleshooting” tab.

All Users

Problem: My file transfers are too slow.

Q: USB 3.0 connection: Is the drive connected via a USB 3.0 to a USB 2.0 port on your computer or hub?

A: If your drive is connected to a USB 2.0 port or hub, this is normal. A SuperSpeed USB 3.0 device can only operate at USB 3.0 performance levels when it is connected directly to a USB 3.0 port or hub.

Q: USB 3.0 connection: Does your computer or operating system support SuperSpeed USB 3.0?

A: Refer to the product packaging or consult the product support web page at [LaCie technical support](#) to check the minimum system requirements.

Q: Is your computer's internal hard drive limiting transfer speeds?

A: If your computer has a low-performance internal hard drive (typically a notebook or netbook computer), it can limit the LaCie device's transfer speed.

Problem: I'm receiving file transfer error messages and/or Time Machine does not work.

Q: Did you get an "Error -50" message while copying to the storage?

A: When copying files or folders from a computer to a FAT32 volume, certain characters cannot be copied. These characters include, but are not limited to:

? < > / \ :

Since it does not offer optimal performance, LaCie does not recommend using the FAT 32 file system with your product. See [Optional Formatting and Partitioning](#) for help in choosing a file system. Additionally, Apple Time Machine is only compatible with disks formatted in HFS+ or HFS+ (Journaled). Reformat the drive for Time Machine compatibility.

Problem: I got an error message telling me that the drive has been disconnected

Q: Did it happen when the computer was coming out of sleep mode?

A: Simply ignore this message. The drive will remount to the desktop. LaCie drives conserve power by spinning down when you set your computer to sleep mode, and when the computer is awoken from sleep, it may not give the drive enough time to spin-up from its sleep mode.

Problem: The displayed available capacity doesn't seem right.

Q: I just moved a lot of files into the Trash/Recycle Bin from my Thunderbolt hard drive. Why isn't this reflected in the displayed available space?

A: Disk space will not be reclaimed until the file is completely erased. To remove the files forever, empty your trash/recycle bin.

Q: Why is the volume capacity less than advertised on the Thunderbolt storage (hard drives only)?

A: After formatting, the available capacity of a drive will show less than advertised on the box. The difference is based upon how capacity is viewed by the operating system. For example, a hard drive that can store 500,000,000,000 bytes is divided by 1,000,000,000 to equal 500GB. This is the actual capacity listed on the manufacturer's box. The operating system uses slightly different math, dividing 500,000,000,000 by 1,073,741,824 to equal 466GB.

Mac

Problem: The drive isn't appearing on my computer.

Q: Is your Finder configured not to show hard drives on the desktop?

A: Go to your Finder and check if **Preferences > General tab > Show these items on the desktop:** and then **Hard Disks** is selected. If not, go on to the next topic.

Q: Is it connected to a Mac that supports Thunderbolt technology?

A: The Thunderbolt connector on your Mac looks similar to the Mini DisplayPort connector. While earlier Macintosh computers include one or more Mini DisplayPorts, they are only used to connect one or more monitors. Please note that legacy Macs with Mini DisplayPorts do not support Thunderbolt technology peripherals such as the LaCie Thunderbolt storage.

Q: Why doesn't my Thunderbolt product mount on my computer?

A: Thunderbolt storage devices require cables specifically constructed for Thunderbolt technology. Go to www.lacie.com for more information on cables that support Thunderbolt technology.

Q: Did you follow the correct installation steps?

A:

- Review the installation steps ([Getting Connected](#)).
 - Only use a cable that supports Thunderbolt technology on a Mac.
 - Check both ends of the cable to make sure they are fully seated in their respective ports.
 - Try disconnecting the cable then wait 10 seconds before reconnecting it.
 - If the drive is still not recognized, restart your computer and try again.
-

Windows

Problem: The drive isn't appearing on my computer.

Q: Are you connecting the product to a host computer via the Thunderbolt interface, and have not installed Thunderbolt drivers?

A: Drivers are required for the Thunderbolt interface. Disconnect the Thunderbolt cable and attach the USB cable. To install drivers, launch LaCie Setup Assistant provided with your device. Once the driver is installed, disconnect the USB cable and connect the Thunderbolt cable. If you no longer have LaCie Setup Assistant on your device, go to [LaCie technical support](#) to download the installer.

Q: Are both ends of the interface cable securely attached?

A:

- Check both ends of the cable to make sure they are fully seated in their respective ports.
- Try disconnecting the cable then wait 10 seconds before reconnecting it.
- If the drive is still not recognized, restart your computer and try again.

Q: Is the drive listed in Device Manager?

A: All LaCie drives appear in at least one place in Device Manager.

To access Device Manager, click on **Start** and select **Run** from the menu. In Windows Vista, the 'Run' option doesn't appear by default, so press [Windows-button] and [R] on your keyboard.

Enter the command: **devmgmt.msc**

Click **OK** and the Device Manager program will open. For troubleshooting, look in the **Disk Drives** section. It might be necessary to click on **+** on the left side.

If you're not sure if your drive is listed, unplug it, then reconnect it. The entry that changes is your LaCie drive.

Q: Does your disk not appear at all?

A: Proceed to physical troubleshooting topics above.

Q: Is your drive listed next to an unusual icon?

A: Windows Device Manager can usually provide information about failures in accessories. It does not display the exact cause, or a solution, but it can assist in troubleshooting most problems.

A problematic device can be found by its unusual icon. Instead of the normal icon based on the type of device, it is instead an exclamation point, question mark, or an X.

Right-click this icon, then choose **Properties**. The **General** tab will show why the device is not working.

Still not working? There may be a hardware defect or other problem. Time to contact www.lacie.com/support/.

Blinking red LED

Q: The LED continues to blink red but I can access my data. What should I do?

A: A constant blinking red LED can mean that one or both hard drives have failed. If the device is formatted for RAID 1 and it can be accessed, you should immediately copy the data to another hard drive. **Do not swap one or both hard drives onsite or in the field.** Doing so will void the LaCie Rugged RAID's warranty. Contact [LaCie technical support](#) to learn how best to repair the device.

Q: The LED continues to blink red and I cannot access my data. What should I do?

A: A constant blinking red LED can mean that one or both hard drives have failed. Unfortunately, all data is lost if a hard drive fails in a RAID 0 configuration. **Do not swap one or both hard drives onsite or in the field.** Doing so will void the LaCie Rugged RAID's warranty. Contact [LaCie technical support](#) to learn how best to repair the device.

PRECAUTIONS

Caution: Modifications not authorized by the manufacturer may void the user's authority to operate this device.

Important info: Any loss, corruption or destruction of data while using a LaCie drive is the sole responsibility of the user, and under no circumstances will LaCie be held liable for the recovery or restoration of this data. To help prevent the loss of your data, LaCie highly recommends that you keep TWO copies of your data; one copy on your external hard disk, for instance, and a second copy either on your internal hard disk, another external hard disk or some other form of removable storage media. If you would like more information on backup, please refer to our website.

Important info: 1TB (Terabyte) = 1,000GB. 1GB = 1000MB. 1MB = 1,000,000 Bytes. Total accessible capacity varies depending upon operating environment (typically up to 10% less per TB).

HEALTH AND SAFETY PRECAUTIONS

- Only qualified persons are authorized to carry out maintenance on this device.
- Read this User Manual carefully and follow the correct procedure when setting up the device.
- Do not open a disk drive or attempt to disassemble or modify it. Never insert any metallic object into the drive to avoid any risk of electrical shock, fire, short-circuiting or dangerous emissions. The disk drive shipped with your LaCie hard drive contains no user-serviceable parts. If it appears to be malfunctioning, have it inspected by a qualified LaCie Technical Support representative.
- Never expose your device to rain, or use it near water, or in damp or wet conditions. Never place objects containing liquids on the LaCie hard drive, as they may spill into its openings. Doing so increases the risk of electrical shock, short-circuiting, fire or personal injury.

GENERAL USE PRECAUTIONS

- Do not expose the LaCie hard drive to temperatures outside the range of 5° C to 30° C (41° F to 86° F); or to operational humidity beyond 10-80%, non-condensing, or non-operating humidity beyond 5-90%, non-condensing. Doing so may damage the LaCie hard drive or disfigure its casing. Avoid placing your LaCie hard drive near a source of heat or exposing it to sunlight (even through a window). Inversely, placing your LaCie hard drive in an environment that is too cold may damage the unit.
- Rated cooling for altitudes up to 2000 meters.
- Do not use the LaCie hard drive near other electrical appliances such as televisions, radios or speakers. Doing so may cause interference which will adversely affect the operation of the other products.
- Do not place the LaCie hard drive near sources of magnetic interference, such as computer displays, televisions or speakers. Magnetic interference can affect the operation and stability of your LaCie hard drive.
- Never use excessive force on your LaCie hard drive. If you detect a problem, consult the troubleshooting section in this manual.
- Protect your LaCie hard drive from excessive exposure to dust during use or storage. Dust can build up inside the device, increasing the risk of damage or malfunction.
- Never use benzene, paint thinners, detergent or other chemical products to clean the outside of the LaCie hard drive. Such products will disfigure and discolor the casing. Instead, use a soft, dry cloth to wipe the device.

WARRANTY INFORMATION

LaCie offers first-rate service and support through our generous three-tiered warranty policy. Our 1-, 2-, 3-, and 5-year policies include comprehensive, complimentary web-based resources, expert in-house technical support, and worldwide repair and/or replacement coverage. To benefit from this warranty, please contact LaCie Support at www.lacie.com/us/support where you can find online support and contact information. You may also contact representatives at the original point of purchase who will be able to help guide you.

Standard warranties vary depending on the product. To verify your product's warranty status and to see which standard warranty is included with your product, type in your product's serial number at www.lacie.com/us/support. If no warranty is listed under your product's name, this means that the warranty has expired.

WARRANTY UPGRADES

If you wish to extend your warranty coverage, you can purchase Silver, Gold, or Platinum Care or Advanced Exchange. For details, see www.lacie.com/warranties.

LEGAL INFORMATION

A standard LaCie limited warranty is included with all products. Please read the terms and conditions below.

LaCie Limited Warranty Policy

LaCie ("LaCie") warrants, to the original purchaser, that this equipment shall be free of defects in materials and workmanship for a period of one (1), two (2), three (3), or five (5) years, depending on the model, from LaCie's date of original shipment when the equipment is used normally and is properly serviced when needed. If you discover a defect covered by the warranty set forth above, your sole and exclusive remedy will be for LaCie, in its sole discretion to (i) repair or replace the product at no charge to you; or, if a repaired unit or replacement product is not available, (ii) to refund the current market value of your product. You acknowledge and agree that replacement product, at the sole option of LaCie, may be a new product or a remanufactured product. In order to receive the remedy set forth above, you must return the product during the warranty period and include with each returned product (i) a copy of your original purchase invoice to verify your warranty; (ii) a Return Material Authorization number; (iii) your name, address and telephone number; (iv) a copy of the bill of sale bearing the appropriate LaCie serial numbers as proof of date of original retail purchase; and (v) a description of the problem. The customer must pay all transportation costs for a returned product. The product will need to be returned to LaCie within the country of original retail purchase. This warranty applies only to hardware products; LaCie software, media, and manuals are licensed and warranted pursuant to separate written agreement. This warranty does not apply if the product has been misused or has been damaged by accident, abuse, misuse, or misapplication; if it has been modified without permission of LaCie; or if any LaCie serial number has been removed or defaced. If a customer has purchased a LaCie Advance Care Option (ACO) to go with this equipment, the ACO shall be valid for three (3) years from activation.

EXCEPT FOR THE LIMITED WARRANTY SET FORTH ABOVE, ALL PRODUCTS ARE SOLD "AS IS" AND LACIE EXPRESSLY DISCLAIMS ALL WARRANTIES OF ANY KIND, WHETHER EXPRESS, IMPLIED OR STATUTORY, INCLUDING THE IMPLIED WARRANTIES OF MERCHANTABILITY, NONINFRINGEMENT AND FITNESS FOR A PARTICULAR PURPOSE. WITHOUT FURTHER LIMITING THE GENERALITY OF THE FOREGOING, DOES NOT WARRANT (1) THE PERFORMANCE OR RESULTS OBTAINED FROM USING THIS PRODUCT, (2) THAT THE PRODUCT IS APPROPRIATE FOR THE CUSTOMER'S PURPOSES, (3) THE MANUAL IS ERROR FREE, OR (4) THAT NO DATA WILL BE LOST WHILE USING THE PRODUCT. THE ENTIRE RISK AS TO THE RESULTS AND PERFORMANCE IS ASSUMED BY THE CUSTOMER. THE WARRANTY AND REMEDIES SET FORTH ABOVE ARE EXCLUSIVE AND IN LIEU OF ALL OTHERS, ORAL OR WRITTEN, EXPRESS OR IMPLIED.

EXCLUSIONS AND LIMITATIONS

This Limited Warranty applies only to hardware products manufactured by or for LaCie that can be identified by the "LaCie" trademark, trade name, or logo affixed to them. The Limited Warranty does not apply to any non-LaCie hardware products or any software, even if packaged or sold with LaCie hardware. Manufacturers, suppliers, or publishers, other than LaCie, may provide their own warranties to the end user purchaser, but LaCie, in so far as permitted by law, provides their products "as is". Software distributed by LaCie with or without the LaCie brand name (including, but not limited to system software) is not covered under this Limited Warranty. Refer to the licensing agreement accompanying the software for details of your rights with respect to its use.

LaCie does not warrant that the operation of the product will be uninterrupted or error-free. LaCie is not responsible for damage arising from failure to follow instructions relating to the product's use. This warranty does not apply: (a) to consumable parts, unless damage has occurred due to a defect in materials or workmanship; (b) to cosmetic damage, including but not limited to scratches, dents and broken plastic on ports; © to damage caused by use with non-LaCie products; (d) to damage caused by accident, abuse, misuse, flood, fire, earthquake or other external causes; (e) to damage caused by operating the product outside the permitted or intended uses described by LaCie; (f) to damage caused by service (including upgrades and expansions) performed by anyone who is not a representative of LaCie or a LaCie Authorized Service Provider; (g) to a product or part that has been modified to alter functionality or capability without the written permission of LaCie; or (h) if any LaCie serial number on the product has been removed or defaced.

No LaCie dealer, agent, or employee is authorized to make any modification, extension, or addition to this warranty.

Any loss, corruption or destruction of data while using a LaCie drive is the sole responsibility of the user, and under no circumstances will LaCie be held liable for the recovery or restoration of this data. To help prevent the loss of your data, LaCie highly recommends that you keep TWO copies of your data; one copy on your external hard disk, for instance, and a second copy either on your internal hard disk, another external hard disk or some other form of removable storage media. LaCie offers a complete line of CD and DVD drives. If you would like more information on backup, please refer to our website.

LACIE IS NOT RESPONSIBLE FOR SPECIAL, INCIDENTAL, OR CONSEQUENTIAL DAMAGES RESULTING FROM ANY BREACH OF WARRANTY, OR UNDER ANY LEGAL THEORY, INCLUDING LOST PROFITS, DOWNTIME, GOODWILL, DAMAGE TO OR REPLACEMENT OF EQUIPMENT AND PROPERTY, AND ANY COSTS OF RECOVERING, REPROGRAMMING, OR REPRODUCING ANY PROGRAM OR DATA STORED IN OR USED WITH LACIE PRODUCTS EVEN IF IT HAS BEEN ADVISED OF THE POSSIBILITY OF SUCH DAMAGES.

Some states do not allow the exclusion or limitation of implied warranties or liability for incidental or consequential damages, so the above limitation or exclusion may not apply to you. This warranty gives you specific legal rights, and you may have other rights, which vary from state to state.

Your opening of your package, your use of the product, or your return of the enclosed Registration Card acknowledges that you have read and agree to the terms of this Agreement. You further agree that it is the complete and exclusive state of the agreement between us and supersedes any proposal or prior agreement, oral or written, and any other communications between us relating to the subject matter of this Agreement.

Read carefully all information related to warranty and precautions of use of your new LaCie product in the user manual.

For products purchased in the United States, you may contact LaCie at 7555 Tech Center Drive, Tigard, Oregon 97223 USA. Email: sales@lacie.com. Website: www.lacie.com. Customer service: 503-844-4503.

Service DOA

On rare occasions, a newly purchased LaCie product may be delivered in non-working order. We are working to avoid these issues, but unfortunately, these situations may arise from time to time. Within the 15 calendar days of purchase, should you experience an issue with your new LaCie product, we ask you to return the product to the place where it was originally bought. You will be required to give a proof of purchase.

Customer Warning

Please be sure to back up your data before returning your drive to LaCie for repair. LaCie cannot under any circumstances guarantee the integrity of data remaining on a returned drive. We make no provisions for data recovery and cannot be held liable for any data loss on drives or media returned to LaCie.

All products returned to LaCie must be securely packaged in their original box and shipped with postage prepaid, except for Products registered under the Advance Care Option.

NOTE TO AUSTRALIAN CUSTOMERS

Our goods come with guarantees that cannot be excluded under the Australian Consumer Law. You are entitled to a replacement or refund for a major failure and for compensation for any other reasonably foreseeable loss or damage. You are also entitled to have the goods repaired or replaced if the goods fail to be of acceptable quality and the failure does not amount to a major failure.

Contact us:

LaCie Australia, 6/151 Beauchamp Rd, Matraville NSW 2036 AUSTRALIA

Phone: 02 8063 3711

Email: info.au@lacie.com

For fast technical support, create a support ticket after registering your product at www.lacie.com/au/register.

LEGAL INFORMATION

COPYRIGHTS

Copyright © 2015 LaCie. All rights reserved. No part of this publication may be reproduced, stored in a retrieval system, or transmitted in any form or by any means, electronic, mechanical, photocopying, recording or otherwise, without the prior written consent of LaCie.

CHANGES

The material in this document is for information only and subject to change without notice. While reasonable efforts have been made in the preparation of this document to assure its accuracy, LaCie assumes no liability resulting from errors or omissions in this document, or from the use of the information contained herein. LaCie reserves the right to make changes or revisions in the product design or the product manual without reservation and without obligation to notify any person of such revisions and changes.

FEDERAL COMMUNICATION COMMISSION INTERFERENCE STATEMENT

This equipment has been tested and found to comply with the limits for a Class B digital device, pursuant to Part 15 of the FCC Rules. These limits are designed to provide reasonable protection against harmful interference in a residential installation. This equipment generates, uses and can radiate radio frequency energy and, if not installed and used in accordance with the instructions, may cause harmful interference to radio communications. However, there is no guarantee that interference will not occur in a particular installation. If this equipment does cause harmful interference to radio or television reception, which can be determined by turning the equipment off and on, the user is encouraged to try to correct the interference by one of the following measures:

1. Reorient or relocate the receiving antenna.
2. Increase the separation between the equipment and receiver.
3. Connect the equipment into an outlet on a circuit different from that to which the receiver is connected.
4. Consult the dealer or an experienced radio/TV technician for help.

FCC Caution: Any changes or modifications not expressly approved by the party responsible for compliance could void the user's authority to operate this equipment.

This device complies with Part 15 of the FCC Rules. Operation is subject to the following two conditions: (1) This device may not cause harmful interference, and (2) this device must accept any interference received, including interference that may cause undesired operation.

Important info: FCC Radiation Exposure Statement: This equipment complies with FCC radiation exposure limits set forth for an uncontrolled environment. This equipment should be installed and operated with minimum distance 20 cm between the radiator & your body.

This transmitter must not be co-located or operating in conjunction with any other antenna or transmitter. The availability of some specific channels and/or operational frequency bands are country dependent and are

firmware programmed at the factory to match the intended destination. The firmware setting is not accessible by the end user.

WEEE



This symbol on the product or on its packaging indicates that this product must not be disposed of with your other household waste. Instead, it is your responsibility to dispose of your waste equipment by handing it over to a designed collection point for the recycling of waste electrical and electronic equipment. The separate collection and recycling of your waste equipment at the time of disposal will help to conserve natural resources and ensure that it is recycled in a manner that protects human health and the environment. For more information about where you can drop off your waste equipment for recycling, please contact your local city office, your household waste disposal service, or the shop where you purchased the product.

MANUFACTURER'S DECLARATION FOR CE CERTIFICATION



We, LaCie, solemnly declare that this product conforms to the following European standards: Electromagnetic Compatibility Directive (2004/108/EC); Low-Voltage Directive: 2006/95/EC

TRADEMARKS

Apple, Mac, Time Machine, and Macintosh are registered trademarks of Apple Computer, Inc. Microsoft, Windows XP, Windows Vista, and Windows 7 are registered trademarks of Microsoft Corporation. Other trademarks mentioned in this manual are the property of their respective owners.

CANADA COMPLIANCE STATEMENT

This Class B digital apparatus meets all requirements of the Canadian Interference-Causing Equipment Regulations.

CAN ICES-3 (B)/NMB-3(B)

JAPAN COMPLIANCE STATEMENT

This is a Class B product based on the standard of the Voluntary Control Council for Interference from Information Technology Equipment (VCCI). If this is used near a radio/TV receiver, it may cause radio interference. Install the equipment according to the manual. This statement does not apply to the LaCie CloudBox.